

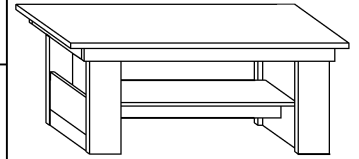

MXS-16 ŁAWA → 125 × 53 × 68

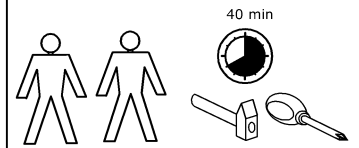

x 8 		x 49 	x 49 	x 10
x 4 	x 2 	x 4 (3,5x16) 		x 1



1 - FAZY MONTAŻU

A - OZNACZENIE ELEMENTÓW

a - OZNACZENIE AKCESORIÓW

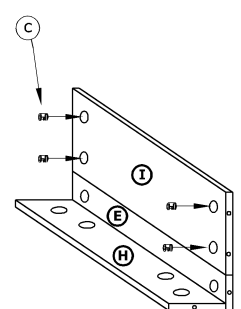
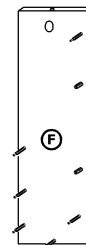
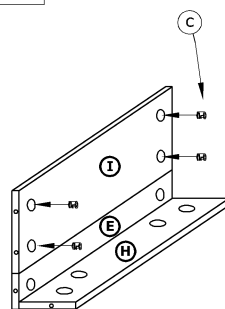
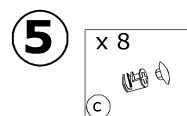
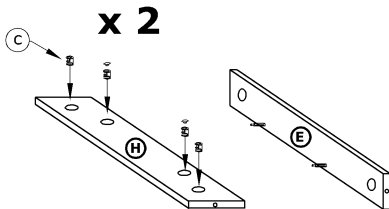
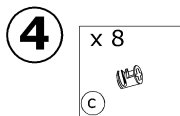
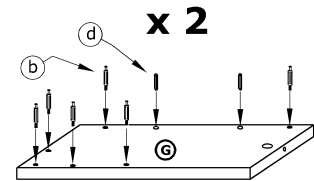
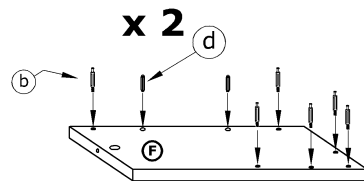
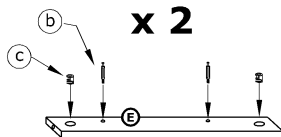
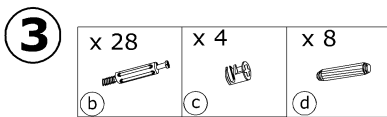
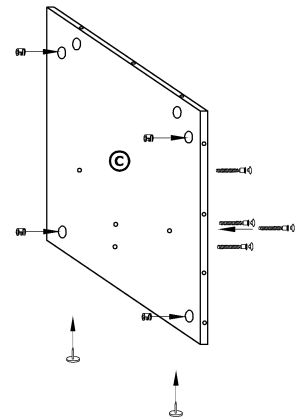
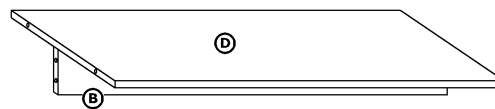
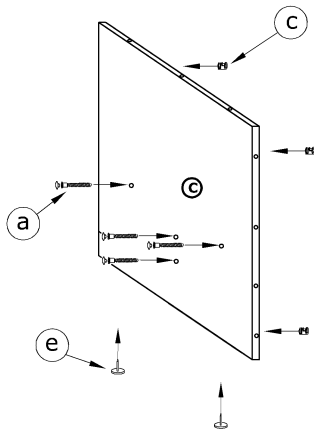
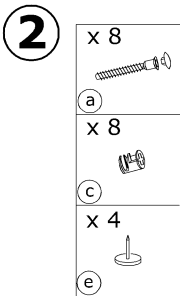
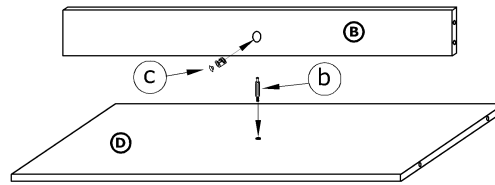
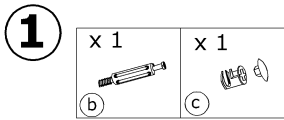

6

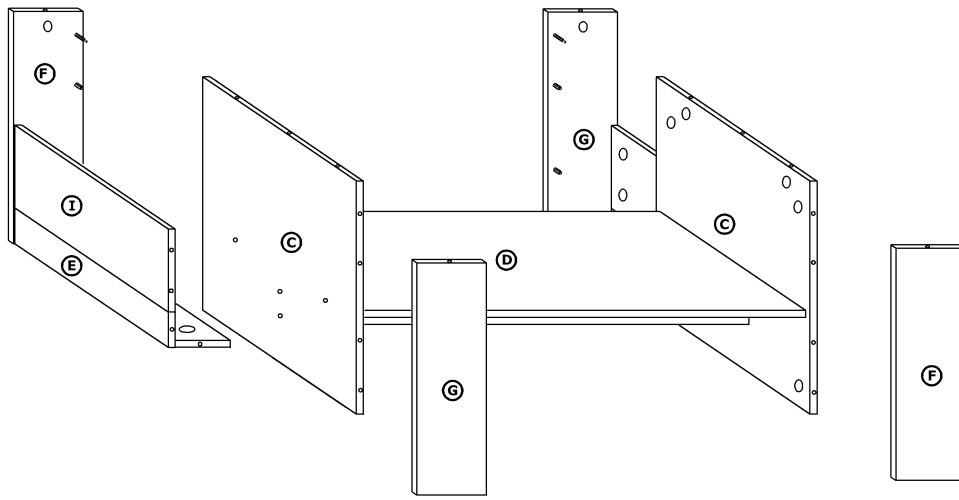

7

- x 4 (b)
- x 2 (f)
- x 2 (3,5x16) (g)

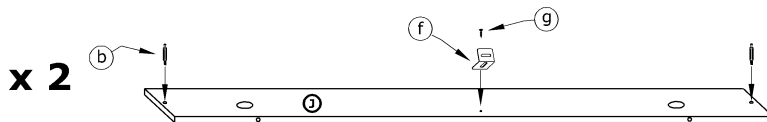

8

- x 4 (c)

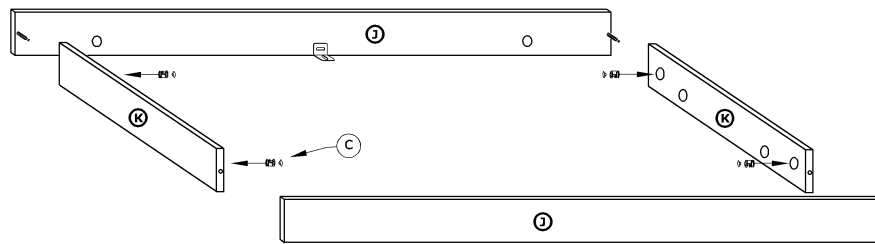

9

- x 16 (b)
- x 8 (c)
- x 2 (d)
- x 2 (3,5x16) (g)

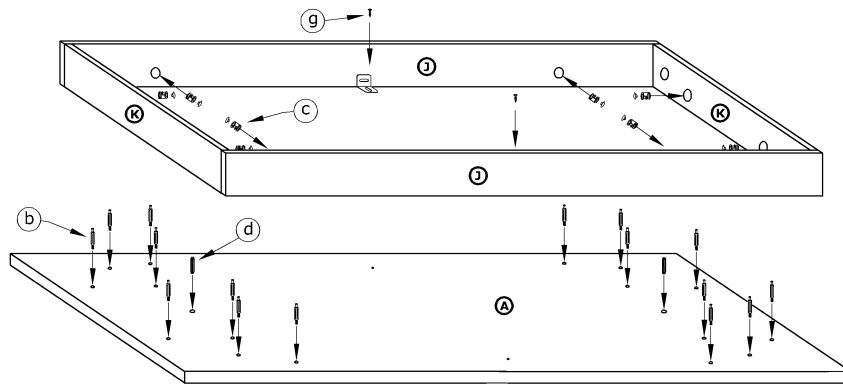

10

- x 8 (c)

